



Features & Benefits

1. High performance and reputable brand led chips and driver
2. Clear polycarbonate lens with no risk of lamp breaking for safe industry applications
3. Optimized aluminum alloy housing design for superior thermal management
4. Instant light up with no warm up time
5. No cool down needed before restart
6. High mechanical impact resistance and ingress protection rating
7. Compact in size and easy for transportation

Options

1. Safety rope
2. 1-10V Dimming
3. 60/90/110 degree lens
4. Adjustable mounting bracket



Dimensions

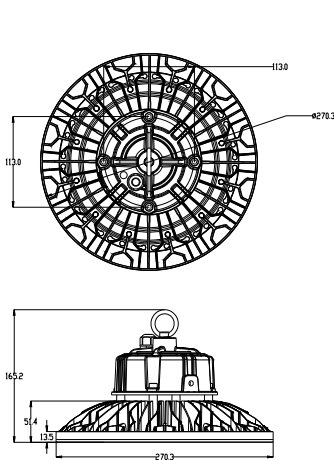

100W

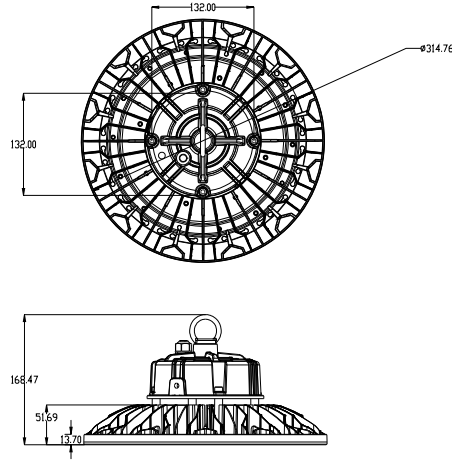

150W

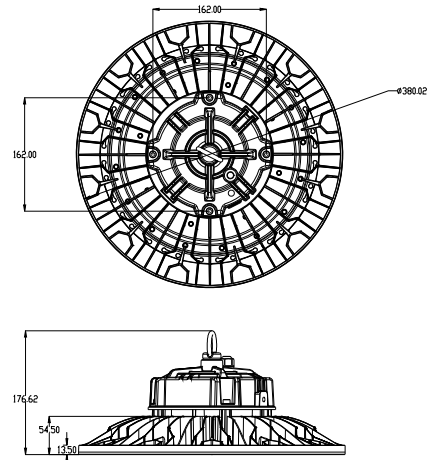

200-240W

Photometry

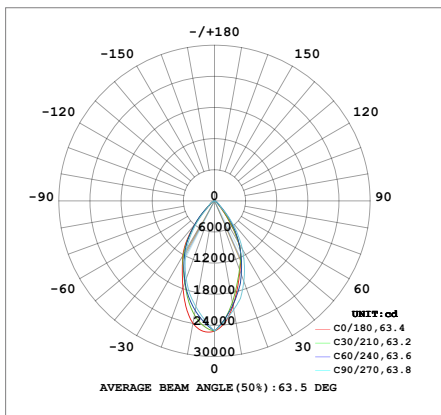

60°

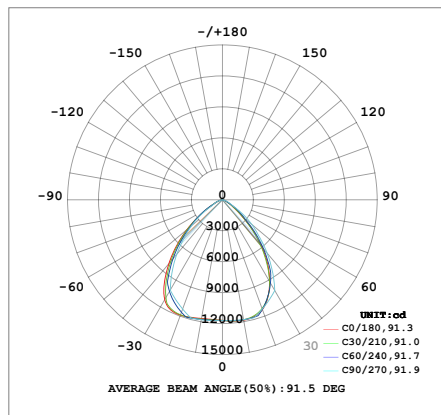

90°

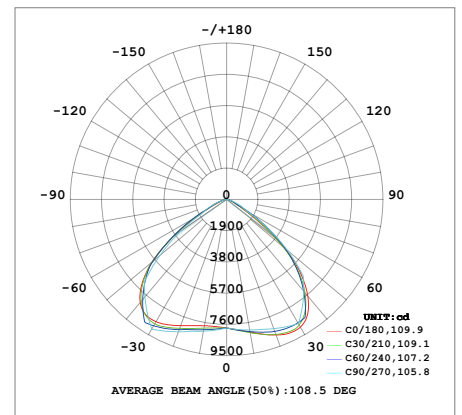

110°



Specifications

- Power Consumption: 100-240W
- Luminous Flux: 16,000lm to 40,800lm
- Input Voltage: 100-277V~
- Color Temperature: 2700-6500K
- IP and IK Rating: IP65 and IK08
- Colour Rendering Index (Ra): 80+
- L70 lumen maintenance: >50, 000 hours
- Power factor: >0.95
- Warranty: 5 years
- Operation Temperature Range: -30°C to+50°C

Ordering Information

Part No	Power	CCT	Flux	Dimming	Diameter	Height	Beam Angle
ISL-UFO-B100W	100W	2700-6500K	16,000-17,000lm	NO	270mm	165mm	60/90/110°
ISL-UFO-B150W	150W	2700-6500K	24,000-25,500lm	NO	315mm	168mm	60/90/110°
ISL-UFO-B200W	200W	2700-6500K	32,000-34,000lm	NO	380mm	176mm	60/90/110°
ISL-UFO-B240W	240W	2700-6500K	38,400-40,800lm	NO	380mm	176mm	60/90/110°

Model	Carton Size	N.W	G.W	QTY
ISL-UFO-B100W	300*300*200mm	2.35KG	3KG	1PCS
ISL-UFO-B150W	350*350*200mm	2.35KG	3.05KG	1PCS
ISL-UFO-B200W	400*400*210mm	3.52KG	4KG	1PCS
ISL-UFO-B240W	400*400*210mm	4.2KG	5KG	1PCS

Telephone: +86-0755-29815402

Email: info@ishinelux.com